





Os

OS Straight





Ø	Articolo	L. 8.5	L. 10	L. 11.5	L. 13
		mm	mm	mm	mm
3,3		-	OS330X10ST	OS330X11.5ST	OS330X13ST
3,85		OS385X8.5ST	OS385X10ST	OS385X11.5ST	OS385X13ST
4,25		OS425X8.5ST	OS425X10ST	OS425X11.5ST	OS425X13ST
5,0		OS500X8.5ST	OS500X10ST	OS500X11.5ST	OS500X13ST



Tutti gli impianti sono confezionati in doppia ampolla sterile.

OS Konico





Ø	Articolo	L. 8.5	L. 10	L. 11.5	L. 13
		mm	mm	mm	mm
3,85		-	OS385X10	OS385X11.5	OS385X13
4,25		-	OS425X10	OS425X11.5	OS425X13
5,0		-	OS500X10	OS500X11.5	OS500X13

Grazie ad un ingaggio robusto, la fixture viene posizionata nel sito chirurgico tramite il tappo della seconda ampolla che funge da mounter trasportatore e che ne permette il facile inserimento in tutte le posizioni, fino al raggiungimento di un torque elevato prima del definitivo completamento mediante connessione da cricchetto o manipolo.



OS Superior



Ø	Articolo	L. 8.5	L. 10	L. 11.5	L. 13
		mm	mm	mm	mm
4,25		-	OSS425X10	OSS425X11.5	-
4,60		-	OSS460X10	OSS460X11.5	-

Os Superior grazie ad una spira larga e aggressiva è particolarmente indicato in tutti i siti post estrattivi, nel mascellare superiore e in presenza di osso D3/D4.

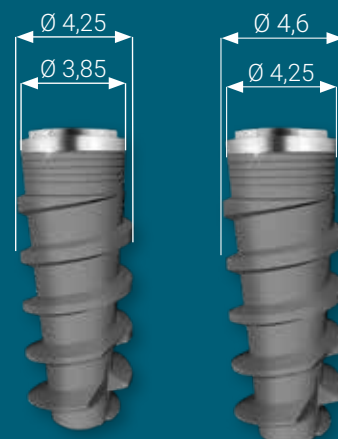

	<p>Vite di guarigione</p> <table border="1"> <thead> <tr> <th>Ø</th> <th>h2</th> <th>h4</th> </tr> </thead> <tbody> <tr> <td>3.3</td> <td>0SVG3302</td> <td>0SVG3304</td> </tr> <tr> <td>3.85</td> <td>0SVG3852</td> <td>0SVG3854</td> </tr> <tr> <td>4.25</td> <td>0SVG4252</td> <td>0SVG4254</td> </tr> <tr> <td>5.0</td> <td>0SVG5002</td> <td>0SVG5004</td> </tr> </tbody> </table>	Ø	h2	h4	3.3	0SVG3302	0SVG3304	3.85	0SVG3852	0SVG3854	4.25	0SVG4252	0SVG4254	5.0	0SVG5002	0SVG5004		<p>Transfer</p> <table border="1"> <thead> <tr> <th>Ø</th> <th colspan="2">codice</th> </tr> </thead> <tbody> <tr> <td>3.3</td> <td colspan="2">-</td> </tr> <tr> <td>3.85</td> <td colspan="2">0STR385</td> </tr> <tr> <td>4.25</td> <td colspan="2">0STR425</td> </tr> <tr> <td>5.0</td> <td colspan="2">0STR500</td> </tr> </tbody> </table>	Ø	codice		3.3	-		3.85	0STR385		4.25	0STR425		5.0	0STR500			<p>Analogo</p> <table border="1"> <thead> <tr> <th>Ø</th> <th>codice</th> </tr> </thead> <tbody> <tr> <td>3.3</td> <td>0SANA330</td> </tr> <tr> <td>3.85</td> <td>0SANA385</td> </tr> <tr> <td>4.25</td> <td>0SANA425</td> </tr> <tr> <td>5.0</td> <td>0SANA500</td> </tr> </tbody> </table>	Ø	codice	3.3	0SANA330	3.85	0SANA385	4.25	0SANA425	5.0	0SANA500
Ø	h2	h4																																											
3.3	0SVG3302	0SVG3304																																											
3.85	0SVG3852	0SVG3854																																											
4.25	0SVG4252	0SVG4254																																											
5.0	0SVG5002	0SVG5004																																											
Ø	codice																																												
3.3	-																																												
3.85	0STR385																																												
4.25	0STR425																																												
5.0	0STR500																																												
Ø	codice																																												
3.3	0SANA330																																												
3.85	0SANA385																																												
4.25	0SANA425																																												
5.0	0SANA500																																												
	<p>Moncone tras mucoso</p> <table border="1"> <thead> <tr> <th>h</th> <th>Ø 3.3</th> <th>Ø 3.85</th> </tr> </thead> <tbody> <tr> <td>0.5</td> <td>0SMD330</td> <td>0SMD385</td> </tr> <tr> <td>2</td> <td>0SMD3302</td> <td>0SMD3852</td> </tr> <tr> <td>3</td> <td>0SMD3303</td> <td>0SMD3853</td> </tr> <tr> <td>4</td> <td>0SMD3304</td> <td>0SMD3854</td> </tr> </tbody> </table>	h	Ø 3.3	Ø 3.85	0.5	0SMD330	0SMD385	2	0SMD3302	0SMD3852	3	0SMD3303	0SMD3853	4	0SMD3304	0SMD3854		<p>Moncone tras mucoso</p> <table border="1"> <thead> <tr> <th>h</th> <th>Ø 4.25</th> <th>Ø 5.0</th> </tr> </thead> <tbody> <tr> <td>0.5</td> <td>0SMD425</td> <td>0SMD500</td> </tr> <tr> <td>2</td> <td>0SMD4252</td> <td>0SMD5002</td> </tr> <tr> <td>3</td> <td>0SMD4253</td> <td>0SMD5003</td> </tr> <tr> <td>4</td> <td>0SMD4254</td> <td>0SMD5004</td> </tr> </tbody> </table>	h	Ø 4.25	Ø 5.0	0.5	0SMD425	0SMD500	2	0SMD4252	0SMD5002	3	0SMD4253	0SMD5003	4	0SMD4254	0SMD5004		<p>Moncone inclinato 15°</p> <table border="1"> <thead> <tr> <th>Ø</th> <th>codice</th> </tr> </thead> <tbody> <tr> <td>3.3</td> <td>0SMA3302</td> </tr> <tr> <td>3.85</td> <td>0SMA385</td> </tr> <tr> <td>4.25</td> <td>0SMA425</td> </tr> <tr> <td>5.0</td> <td>0SMA500</td> </tr> </tbody> </table>	Ø	codice	3.3	0SMA3302	3.85	0SMA385	4.25	0SMA425	5.0	0SMA500
h	Ø 3.3	Ø 3.85																																											
0.5	0SMD330	0SMD385																																											
2	0SMD3302	0SMD3852																																											
3	0SMD3303	0SMD3853																																											
4	0SMD3304	0SMD3854																																											
h	Ø 4.25	Ø 5.0																																											
0.5	0SMD425	0SMD500																																											
2	0SMD4252	0SMD5002																																											
3	0SMD4253	0SMD5003																																											
4	0SMD4254	0SMD5004																																											
Ø	codice																																												
3.3	0SMA3302																																												
3.85	0SMA385																																												
4.25	0SMA425																																												
5.0	0SMA500																																												
	<p>Moncone inclinato 25°</p> <table border="1"> <thead> <tr> <th>Ø</th> <th>codice</th> </tr> </thead> <tbody> <tr> <td>3.3</td> <td>-</td> </tr> <tr> <td>3.85</td> <td>0SMA253852</td> </tr> <tr> <td>4.25</td> <td>0SMA254252</td> </tr> <tr> <td>5.0</td> <td>0SMA255002</td> </tr> </tbody> </table>	Ø	codice	3.3	-	3.85	0SMA253852	4.25	0SMA254252	5.0	0SMA255002		<p>Moncone transfer</p> <table border="1"> <thead> <tr> <th>Ø</th> <th>h1.5</th> <th>h 2.5</th> </tr> </thead> <tbody> <tr> <td>3.85</td> <td>0SMTR385</td> <td>0SMTR3852</td> </tr> <tr> <td>4.25</td> <td>0SMTR425</td> <td>0SMTR4252</td> </tr> <tr> <td>5.0</td> <td>0SMTR500</td> <td>0SMTR5002</td> </tr> </tbody> </table>	Ø	h1.5	h 2.5	3.85	0SMTR385	0SMTR3852	4.25	0SMTR425	0SMTR4252	5.0	0SMTR500	0SMTR5002		<p>Moncone fresabile</p> <table border="1"> <thead> <tr> <th>Ø</th> <th>codice</th> </tr> </thead> <tbody> <tr> <td>3.85</td> <td>0SMF385</td> </tr> <tr> <td>4.25</td> <td>0SMF425</td> </tr> <tr> <td>5.0</td> <td>0SMF500</td> </tr> </tbody> </table>	Ø	codice	3.85	0SMF385	4.25	0SMF425	5.0	0SMF500										
Ø	codice																																												
3.3	-																																												
3.85	0SMA253852																																												
4.25	0SMA254252																																												
5.0	0SMA255002																																												
Ø	h1.5	h 2.5																																											
3.85	0SMTR385	0SMTR3852																																											
4.25	0SMTR425	0SMTR4252																																											
5.0	0SMTR500	0SMTR5002																																											
Ø	codice																																												
3.85	0SMF385																																												
4.25	0SMF425																																												
5.0	0SMF500																																												
	<p>Moncone provvisorio in resina</p> <table border="1"> <thead> <tr> <th>Ø</th> <th>codice</th> </tr> </thead> <tbody> <tr> <td>3.85</td> <td>0SMR385</td> </tr> <tr> <td>4.25</td> <td>0SMR425</td> </tr> <tr> <td>5.0</td> <td>0SMR500</td> </tr> </tbody> </table>	Ø	codice	3.85	0SMR385	4.25	0SMR425	5.0	0SMR500		<p>Cilindro calcinabile N/R non rotante</p> <table border="1"> <thead> <tr> <th>Ø</th> <th>codice</th> </tr> </thead> <tbody> <tr> <td>3.85</td> <td>0SCC385</td> </tr> <tr> <td>4.25</td> <td>0SCC425</td> </tr> <tr> <td>5.0</td> <td>0SCC500</td> </tr> </tbody> </table>	Ø	codice	3.85	0SCC385	4.25	0SCC425	5.0	0SCC500		<p>Cilindro calcinabile R Rotante</p> <table border="1"> <thead> <tr> <th>Ø</th> <th>codice</th> </tr> </thead> <tbody> <tr> <td>3.85</td> <td>0SCCR385</td> </tr> <tr> <td>4.25</td> <td>0SCCR425</td> </tr> <tr> <td>5.0</td> <td>-</td> </tr> </tbody> </table>	Ø	codice	3.85	0SCCR385	4.25	0SCCR425	5.0	-																
Ø	codice																																												
3.85	0SMR385																																												
4.25	0SMR425																																												
5.0	0SMR500																																												
Ø	codice																																												
3.85	0SCC385																																												
4.25	0SCC425																																												
5.0	0SCC500																																												
Ø	codice																																												
3.85	0SCCR385																																												
4.25	0SCCR425																																												
5.0	-																																												
	<p>Attacco sferico</p> <table border="1"> <thead> <tr> <th>h</th> <th>Ø 3.3</th> <th>Ø 3.85</th> </tr> </thead> <tbody> <tr> <td>1</td> <td>0SASF3301</td> <td>0SASF3851</td> </tr> <tr> <td>2</td> <td>0SASF3302</td> <td>0SASF3852</td> </tr> <tr> <td>3</td> <td>0SASF3303</td> <td>0SASF3853</td> </tr> <tr> <td>4</td> <td>0SASF3304</td> <td>0SASF3854</td> </tr> </tbody> </table>	h	Ø 3.3	Ø 3.85	1	0SASF3301	0SASF3851	2	0SASF3302	0SASF3852	3	0SASF3303	0SASF3853	4	0SASF3304	0SASF3854		<p>Attacco sferico</p> <table border="1"> <thead> <tr> <th>h</th> <th>Ø 4.25</th> <th>Ø 5.0</th> </tr> </thead> <tbody> <tr> <td>1</td> <td>0SASF4251</td> <td>0SASF5001</td> </tr> <tr> <td>2</td> <td>0SASF4252</td> <td>0SASF5002</td> </tr> <tr> <td>3</td> <td>0SASF4253</td> <td>0SASF5003</td> </tr> <tr> <td>4</td> <td>0SASF4254</td> <td>0SASF5004</td> </tr> </tbody> </table>	h	Ø 4.25	Ø 5.0	1	0SASF4251	0SASF5001	2	0SASF4252	0SASF5002	3	0SASF4253	0SASF5003	4	0SASF4254	0SASF5004		<p>Cappetta in teflon cod. CN006</p>										
h	Ø 3.3	Ø 3.85																																											
1	0SASF3301	0SASF3851																																											
2	0SASF3302	0SASF3852																																											
3	0SASF3303	0SASF3853																																											
4	0SASF3304	0SASF3854																																											
h	Ø 4.25	Ø 5.0																																											
1	0SASF4251	0SASF5001																																											
2	0SASF4252	0SASF5002																																											
3	0SASF4253	0SASF5003																																											
4	0SASF4254	0SASF5004																																											
	<p>MPA dritto</p> <table border="1"> <thead> <tr> <th>h</th> <th>Ø 3.85</th> <th>Ø 4.25</th> </tr> </thead> <tbody> <tr> <td>1.5</td> <td>0SMPA123</td> <td>0SMPA132</td> </tr> <tr> <td>3</td> <td>0SMPA124</td> <td>0SMPA133</td> </tr> </tbody> </table>	h	Ø 3.85	Ø 4.25	1.5	0SMPA123	0SMPA132	3	0SMPA124	0SMPA133		<p>Cilindro provvisorio in titanio per MPA</p> <p>cod. OSMDMPA</p>		<p>Cilindro calcinabile per MPA</p> <p>cod. OSCCMPA</p>																															
h	Ø 3.85	Ø 4.25																																											
1.5	0SMPA123	0SMPA132																																											
3	0SMPA124	0SMPA133																																											
	<p>Connessione per cricchetto per viti monconali</p> <p>L12 L17</p>		<p>Connessione per manipolo per viti monconali</p> <p>cod. HTRA</p>		<p>Connessione per cricchetto per impianto</p> <table border="1"> <thead> <tr> <th>Ø 3.3/3.85</th> <th>Ø 4.25/5.0</th> </tr> </thead> <tbody> <tr> <td>L10</td> <td>L10</td> </tr> <tr> <td>L17</td> <td>L17</td> </tr> </tbody> </table>	Ø 3.3/3.85	Ø 4.25/5.0	L10	L10	L17	L17																																		
Ø 3.3/3.85	Ø 4.25/5.0																																												
L10	L10																																												
L17	L17																																												
	<p>Cricchetto dinamometrico con regolazione del torque da 0 a 35 Ncm</p> <p>Cricchetto fisso</p>		<p>Fresa lancia corticale</p> <p>Fresa chirurgica cilindrica Ø 2.0 / 2.5 / 2.8 / 3.0 / 3.5 / 4.2</p>		<p>Fresa finale per impianto conico (con countersink)</p> <table border="1"> <thead> <tr> <th>Ø</th> <th colspan="3">Lunghezza</th> </tr> </thead> <tbody> <tr> <td>3.85</td> <td>L10</td> <td>L11.5</td> <td>L13</td> </tr> <tr> <td>4.25</td> <td>L10</td> <td>L11.5</td> <td>L13</td> </tr> <tr> <td>5.0</td> <td>L10</td> <td>L11.5</td> <td>L13</td> </tr> </tbody> </table>	Ø	Lunghezza			3.85	L10	L11.5	L13	4.25	L10	L11.5	L13	5.0	L10	L11.5	L13																								
Ø	Lunghezza																																												
3.85	L10	L11.5	L13																																										
4.25	L10	L11.5	L13																																										
5.0	L10	L11.5	L13																																										

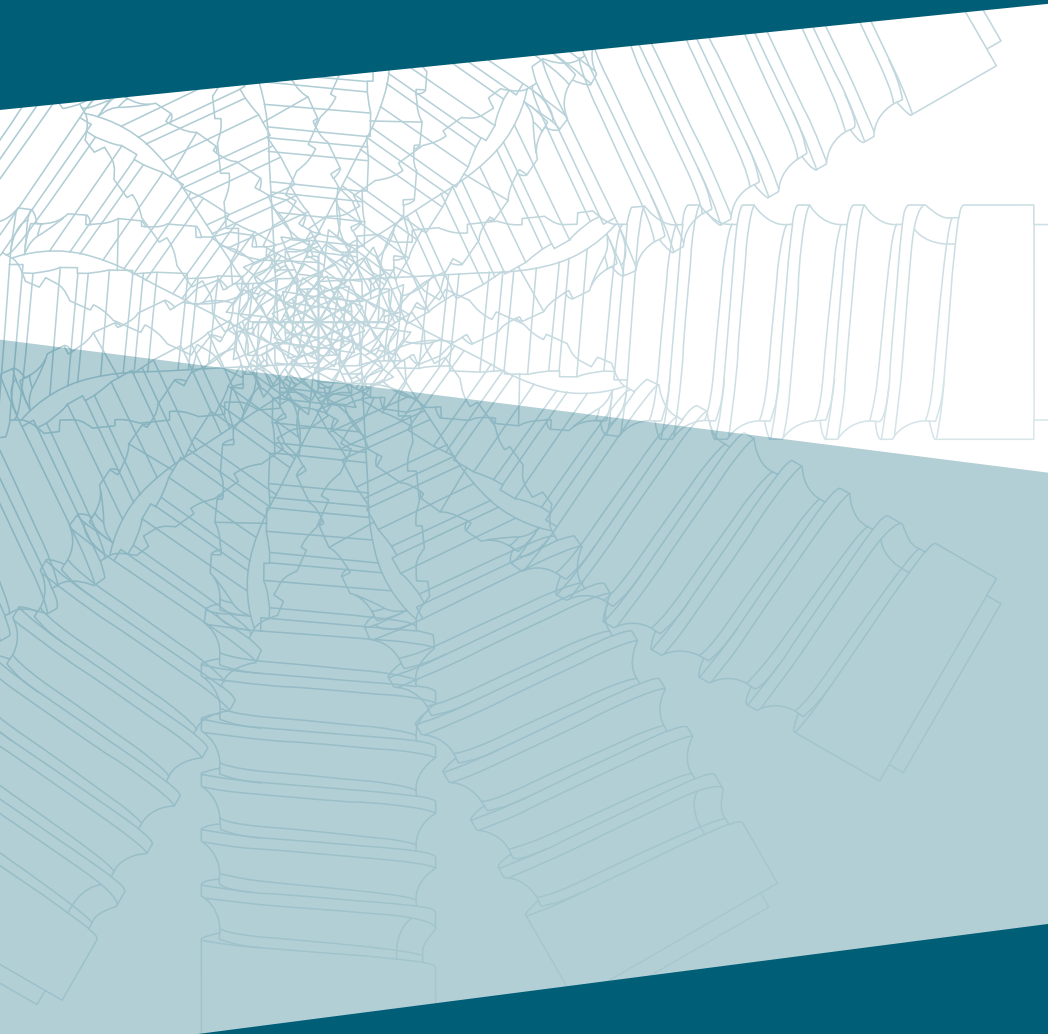

meté
Biointegrated Dental Implants

Via Sciesa, 40/C
21013 Gallarate (VA)
Tel./Fax: +39 0331.796417
www.dentalmete.it